

TERZI
Metalurgica Industrial Ltda.

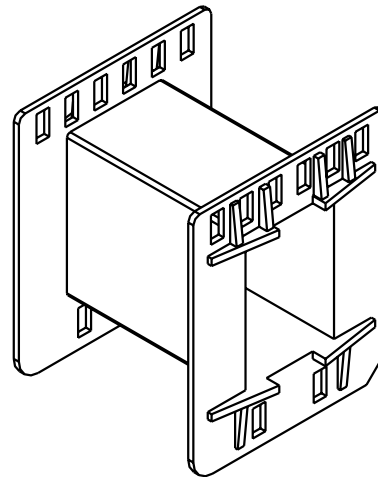
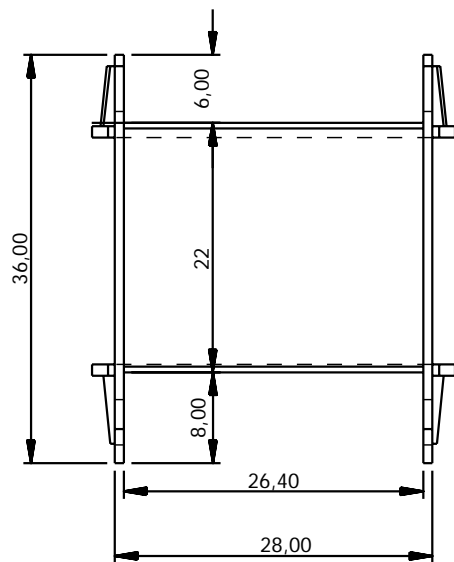

Produto	Carretel
Material	Plastico
Tolerancia	+/- 0.20mm
Escala	1.5:1
Des. N°	48

Cod. TRZ 4220.000.1 EE 42/20 sem terminais