

**TERZI**  
**Metalurgica Industrial Ltda.**

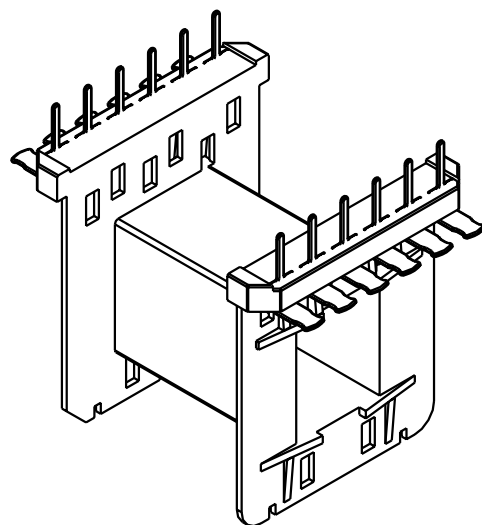
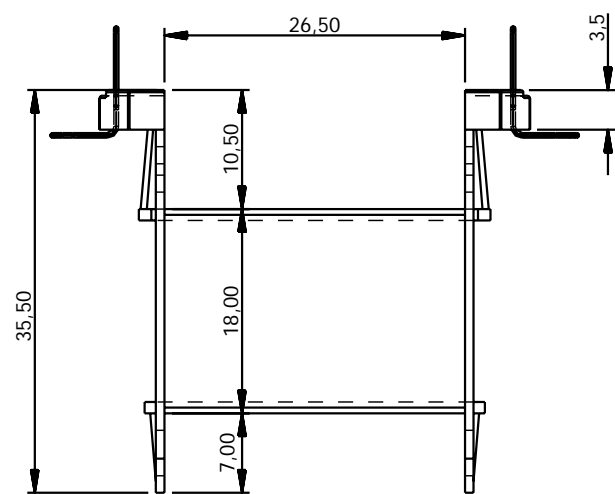

Produto	Carretel
Material	Plastico
Tolerancia	+/- 0.20mm
Escala	1.5:1
Des. N°	47

Cod. TRZ 4215.012.3 EE 42/15 12 terminais