

TERZI
Metalurgica Industrial Ltda.

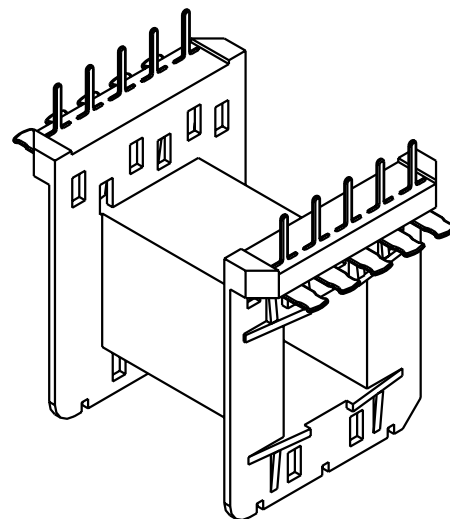
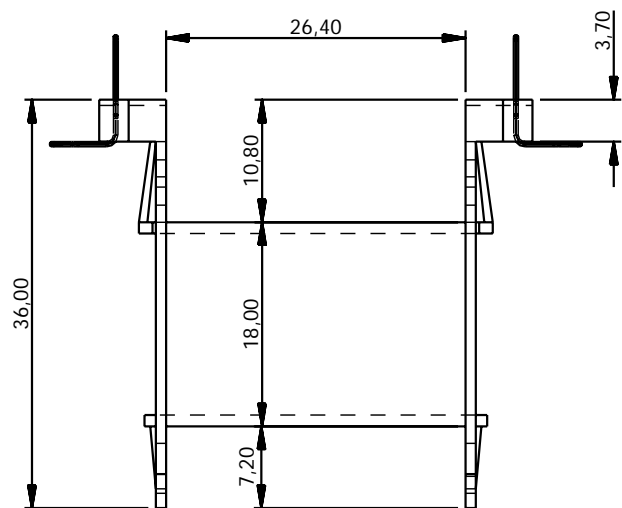

Produto	Carretel
Material	Plastico
Tolerancia	+/- 0.20mm
Escala	1.5:1
Des. N°	46

Cod. TRZ 4215.010.2 EE 42/15 10 terminais