

TERZI
Metalurgica Industrial Ltda.

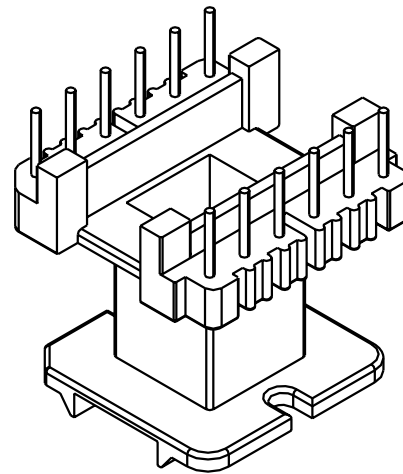
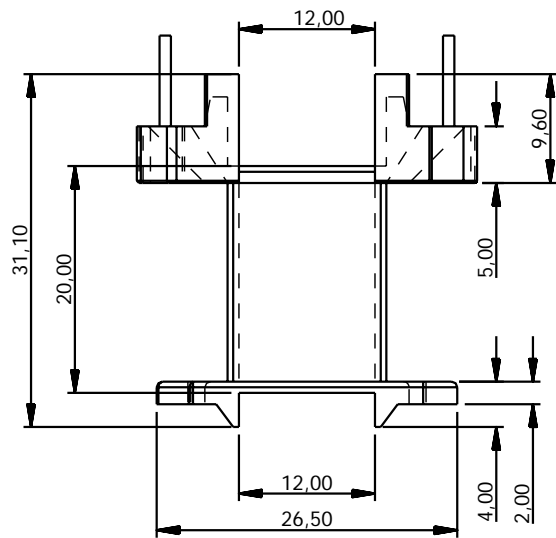

Produto	Carretel
Material	Baquelite
Tolerancia	+/- 0.20mm
Escala	1.5:1
Des. N°	36

Cod. TRZ 40.012.1 EI 40 12 terminais passo 25.0mm