

TERZI
Metalurgica Industrial Ltda.

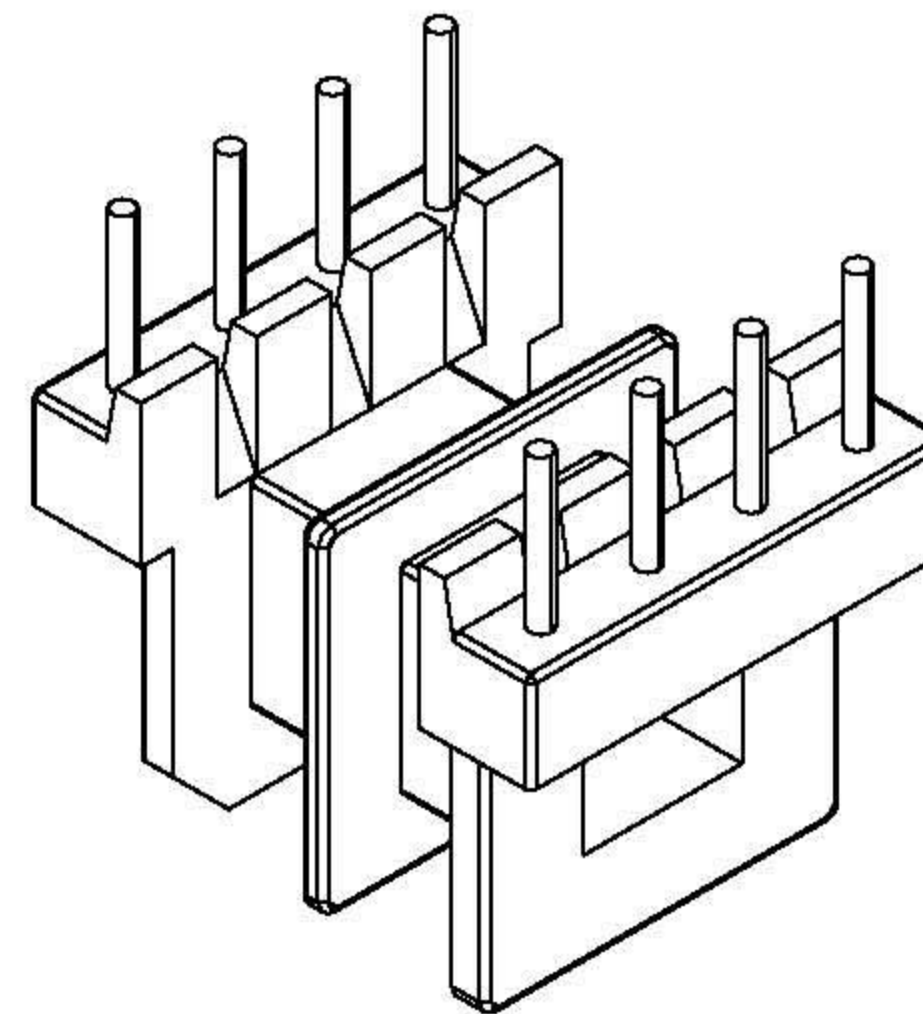
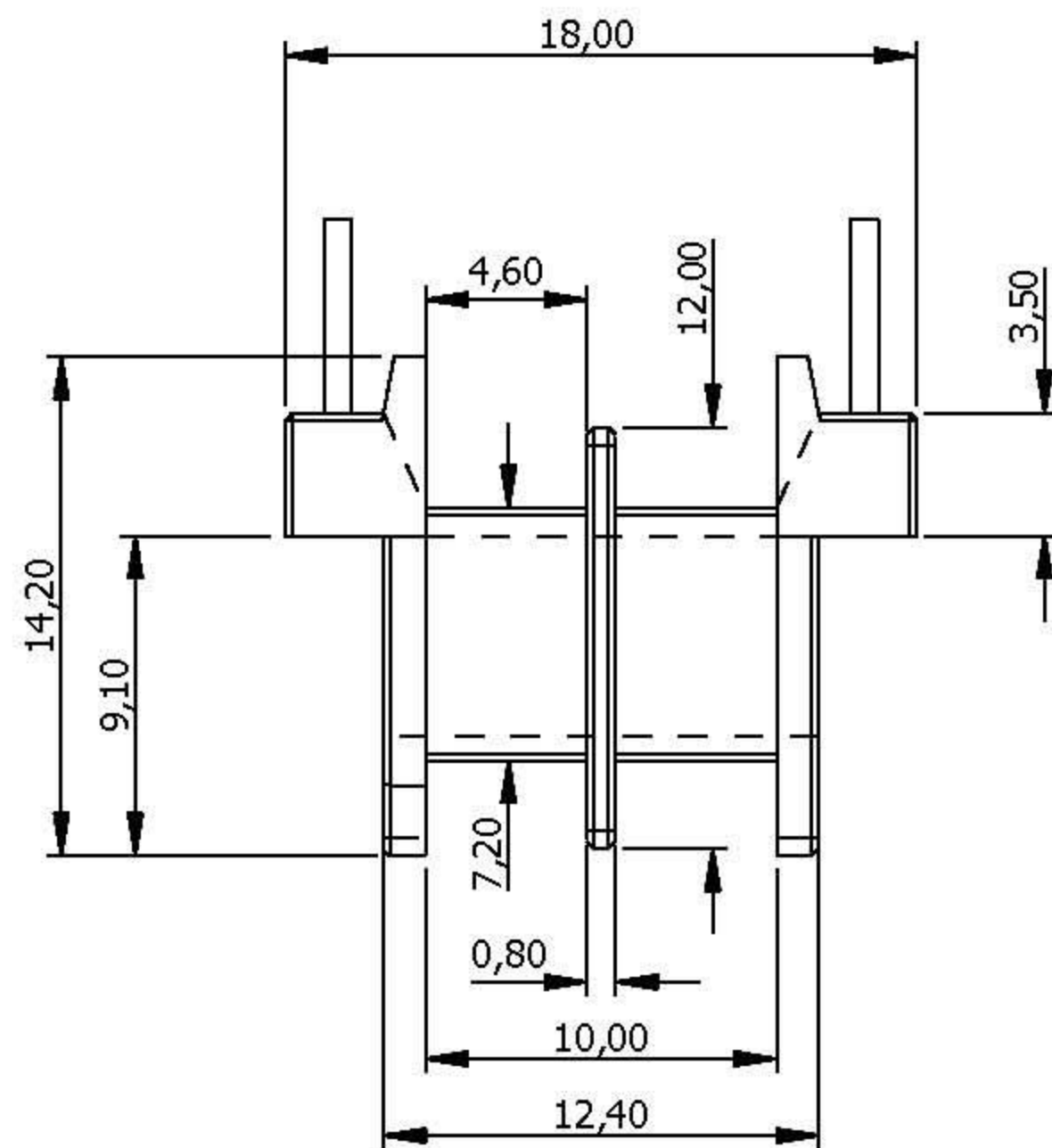

Produto	Carretel
Material	Baquelite
Tolerancia	+/- 0.20mm
Escala	2.5:1
Des. N°	24

Cod. TRZ 20.008.9 E 20 08 terminais horizontal com 1 divisao passo 3.8mm