

TERZI
Metalurgica Industrial Ltda.

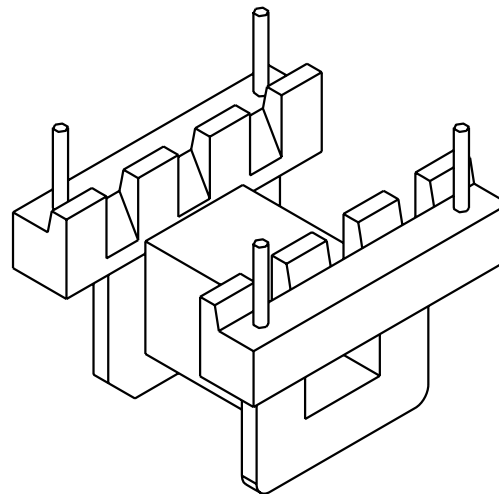
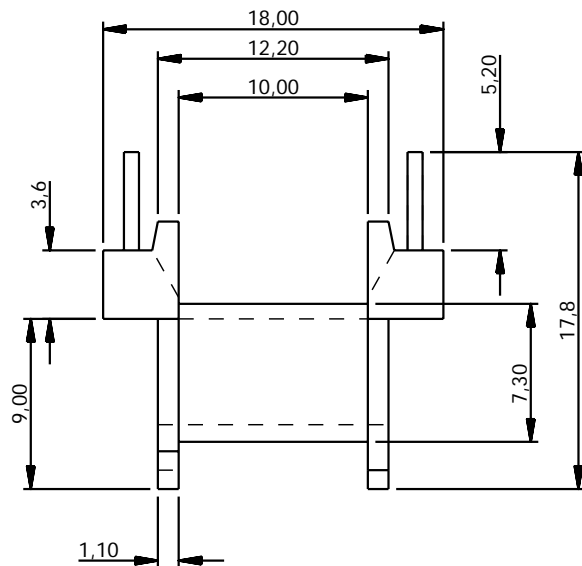

Produto	Carretel
Material	Baquelite
Tolerancia	+/- 0.20mm
Escala	2.5:1
Des. N°	18

Cod. TRZ 20.004.6 E 20 04 terminais horizontal passo 5.0 mm