

TERZI
Metalurgica Industrial Ltda.

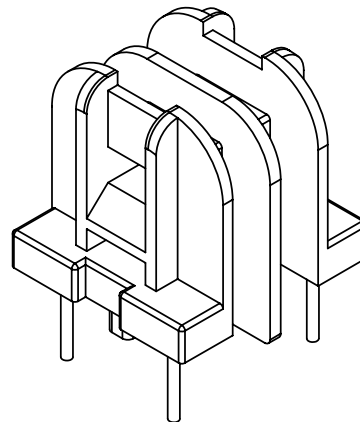
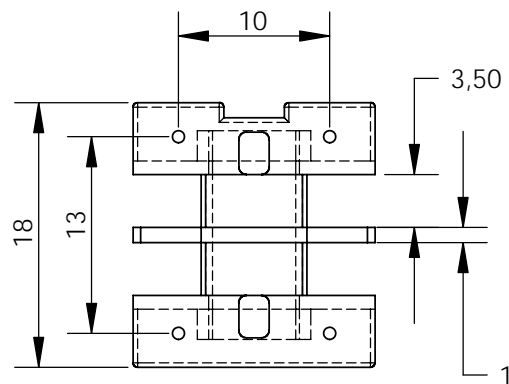

Produto	Carretel
Material	Baquelite
Tolerância	+/- 0.20mm
Escala	2:1
Des. N°	3

Cód. TRZ 11.004.1 C11 04 terminais com divisão